

D 1. ACHTERWAARTSE SIGNALISTATIE - Signalisation arrière - Rear signalization

CONTOURMARKERINGSTAPE

Marquage périphérique
Conspicuity tape

50 m x 50,8 mm

- Norm EC104
- **Zelfklevend** / Autocollant / self-adhesive
- D.G. **Reflecterend** / Réfléchissant / Reflective



Kleur / Couleur / Colour	Ondergrond / Surface	Ref.
	Vast / solide / fixed	SLIRETA55R
		SLIRETA55G
		SLIRETA55W
	Flexibel / flexible	SLIRETA55RFL
		SLIRETA55GFL
		SLIRETA55WFL

Conform wetgeving contourmarkering: K.B. van 7 mei 2010 (Europese richtlijnen 2007/35/EG en 2008/89/EG)
Conforme à la législation par rapport au marquage de poids-lourds, voir A.R. du 7 mai 2010 (régulations européennes 2007/35/EG et 2008/89/EG)
Compliant with truck marking regulation, Royal Decree dd. 7th May 2010 (European guidelines 2007/35/EG and 2008/89/EG)

VRACHTWAGEN > 3500kg

Poids-lourd
Truck

Zelfklevend / autocollant / self-adhesive ref. SLIRETA5613
Aluminium / Aluminum ref. SLIRETA5613A

Zelfklevend / autocollant / self-adhesive ref. SLIRETA11414
Aluminium / Aluminum ref. SLIRETA11414A

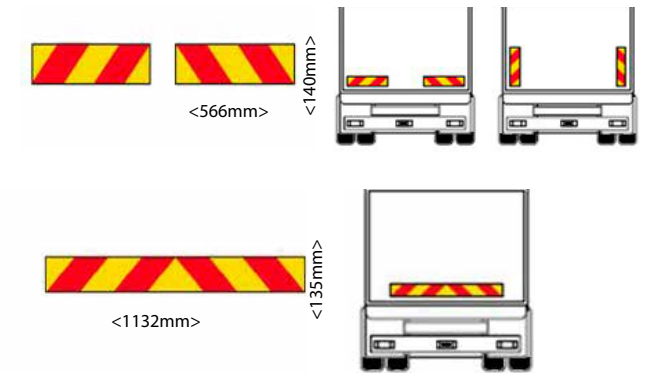

OPLEGGER > 3500kg

Remorque
Trailer

Zelfklevend / autocollant / self-adhesive ref. SLIRETA5619
Aluminium / Aluminum ref. SLIRETA5619A

Zelfklevend / autocollant / self-adhesive ref. SLIRETA11420
Aluminium / Aluminum ref. SLIRETA11420A

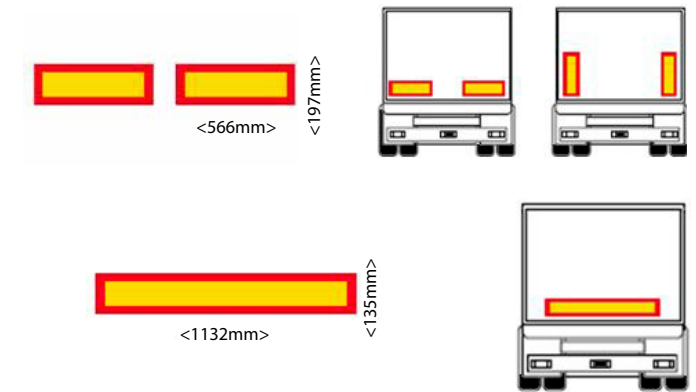

LAADKLEPVLAGGEN (SET VAN 2) MET ALU HOUDER

Signalisation porte de chargement (set de 2) incl. fixation en aluminium
Loading bridge flags (set of 2) incl aluminum fixation

400 x 210 mm ref. SLIRELAKL

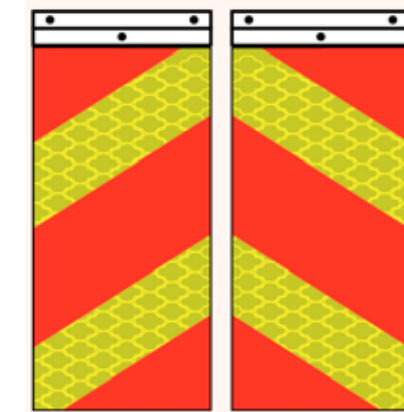

OVERLASTPANEEL VOLLEDIG REFLECTEREND KL II

Panneau complètement rétro réfléchissant CL II 2
Fully reflective warning sign CL II 2

500 x 500 mm ref. SIBOOVLA



REFLECTERENDE FOLIE ROOD-WIT GEARCEERD

Film rouge/blanc réfléchissant hachuré
Reflective foil red/white hatched

B 610 mm ref. SLIREFRW61

bij bestelling aub LINKS of RECHTS specificeren + lengte
veuillez préciser GAUCHE ou DROITE lors de la commande + longueur
please specify LEFT or RIGHT at order + length

STICKERS

Ø 200, 300, 400 mm, CL I ref. SIBOST

vb. A31, D1, ...



D 2. GEVAREN- EN VOUSDRIEHOEK - Triangle de danger - Warning triangle

VOUSDRIEHOEK REFLECTEREND

Triopan pliable réfléchissant
Reflective foldable tripod

A31 ref. SIDRIHA31
A51 ref. SIDRIHA51
Explosiegevaar / Risque explosion / Explosion risk ref. SIDRIHAEX

H 1200 mm, ± 3,8 kg

- 3 gelijke zijdes 600 mm (750 mm op aanvraag)
- KL II reflectie
- In 1 beweging dicht te vouwen
- Compact in transport

- 3 faces identiques 600 mm (750 mm sur demande)
- CL II réflexion
- Pliable en 1 seul mouvement
- Compacte en transport

- 3 identical sides 600 mm (750 mm on request)
- CL II reflection
- Foldable in only 1 action
- Compact for transport

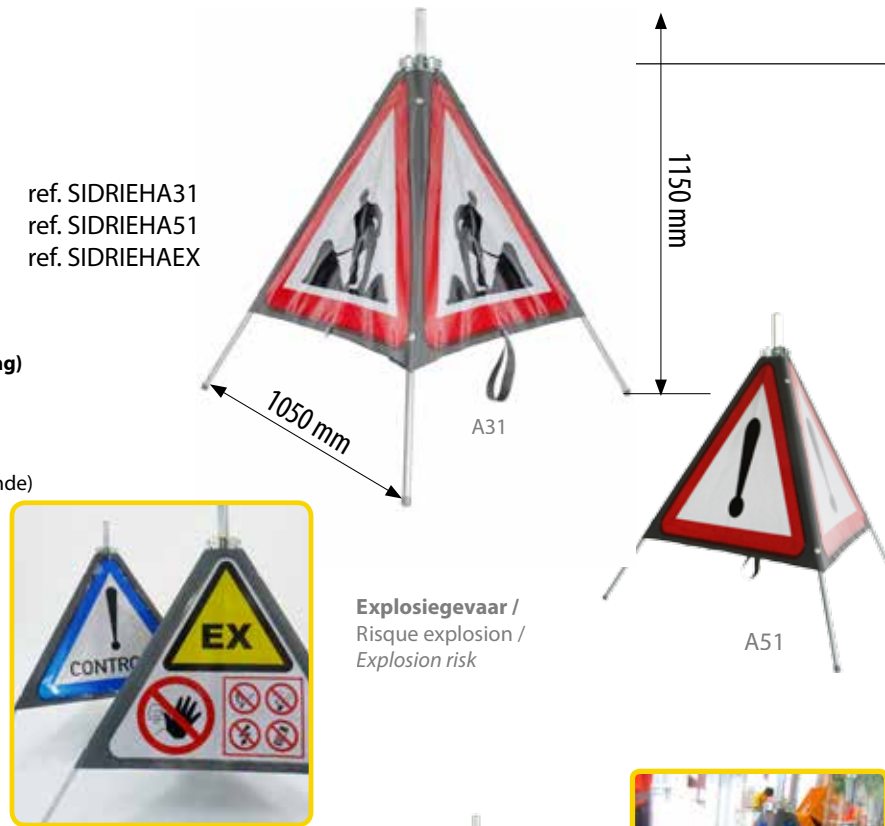

Explosiegevaar /
Risque explosion /
Explosion risk

Vanaf 10 st verschillende zijdes en/of personalisatie mogelijk

A partir de 10 pcs différentes faces et/ou personnalisation possible
As from 10 pcs different sides and/or personalization possible

ref. SIDRIVARIA



HOES VOOR VOUSDRIEHOEK

Housse pour triopan
Slip cover for triangle

ref. SIDRIHOES



GEVARENDRIEHOEK

Triangle de signalisation
Warning triangle

Zijde / side 430 mm

ref. VAGEVDRIE

CL I, box 450 x 50 x 30 mm

Opvouwbaar in compacte transportbox
Pliable en boîte de transport compacte
Foldable into compact transportbox



D 3. ADR / Dangerous Goods Transport



COMPLEET ADR GAMMA VERKRIJGBAAR IN VINYL OF ALUMINIUM UITVOERING

Large assortment de produits ADR disponible en vinyl ou aluminium
 Large range of Dangerous Goods products available in vinyl or aluminium
 ref. SIADR

Standaard uitvoering: Zelfklevende Vinyl 250 x 250 mm, zeefdruk, lijm bestand tegen onderdompeling in zee water

Exécution standard: Vinyl autocollant 250 x 250 mm, imprime sérigraphie, col résistant à la submersion l'eau de mer

Standard execution: Self-adhesive Vinyl 250 x 250 mm, silk screen print, glue resistant to submerging in sea water

ref. SIADR25VIN...

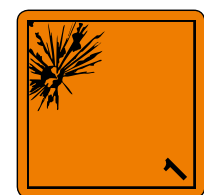

ADR 1.0
SIADR25VIN21301



ADR 2.0
SIADR25VIN21305



ADR 2.2
SIADR25VIN21306

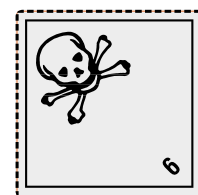

ADR 2.3
SIADR25VIN21307



ADR 3.0
SIADR25VIN21308



ADR 4.1
SIADR25VIN21309

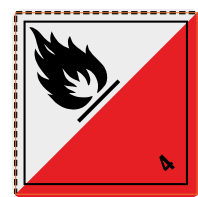

ADR 4.2
SIADR25VIN21310



ADR 4.3
SIADR25VIN21311



ADR 5.1
SIADR25VIN21312



ADR 5.2
SIADR25VIN21313



ADR 6.1
SIADR25VIN21314



ADR 6.2
SIADR25VIN21315

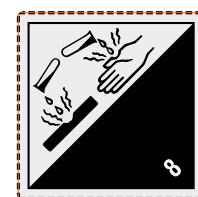

ADR 8.0
SIADR25VIN21321

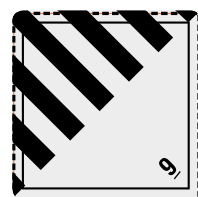

ADR 9.0
SIADR25VIN21322

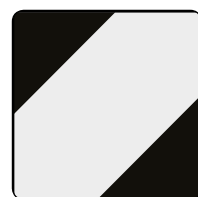

LQ
SIADR25VIN21323

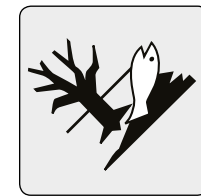

EHS
SIADR25VIN21324



ADR 1.0
SIADR25VIN21301



ADR 2.0
SIADR25VIN21305



ADR 2.2
SIADR25VIN21306



ADR 2.3
SIADR25VIN21307



ADR 3.0
SIADR25VIN21308



ADR 4.1
SIADR25VIN21309



ADR 4.2
SIADR25VIN21310



ADR 4.3
SIADR25VIN21311

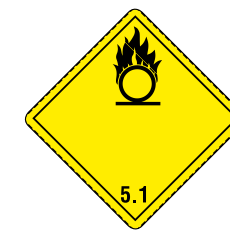

ADR 5.1
SIADR25VIN21312



ADR 5.2
SIADR25VIN21313



ADR 6.1
SIADR25VIN21314



ADR 6.2
SIADR25VIN21315



ADR 8.0
SIADR25VIN21321

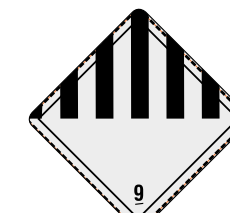

ADR 9.0
SIADR25VIN21322

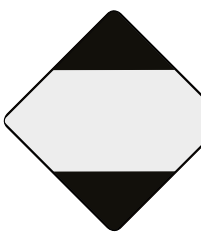

LQ
SIADR25VIN21323

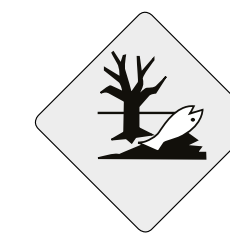

EHS
SIADR25VIN21324

Andere materialen & afmetingen op aanvraag / Autres matériaux & dimensions sur demande / Other materials & dimensions available on request

Kemlerborden & cijfers beschikbaar op aanvraag / Plaques ADR avec différentes chiffres sur demande / Signs with different numbers on request



E 1. ZWAAILAMPEN - Gyrophares - Rotating lights

**ZWAAILICHT TYPE 702**

Gyrophare
Rotating light

12V - 55W - H 180 mm - Ø 150 mm

Vaste plaatsing
Montage fixe
Fixed mounting

ref. SLA702VA



Magnetisch
Magnétique
Magnetic

ref. SLA702MA



DIN-A montage
Montage DIN-A
DIN-A montage

ref. SLA702DA

**ZWAAILICHT MET SIGARETTENPLUG TYPE 131**

Gyrophare avec allume-cigare
Rotating light with cigarette plug

Magnetisch / magnétique / magnetic
12V, H 220 mm - Ø 170 mm ref. SL131A12M

**MAGNETISCH ZWAAILICHT MET SIGARETTENPLUG**

Gyrophare magnétique avec allume-cigare
Magnetic rotating light with cigarette plug

12V

■ ref. SLA120TDR
■ ref. SLA120TDB
■ ref. SLA120TDO
■ ref. SLA120TDG

E 2. BLITSLAMPEN + LED - Strobes + LED

STROBE XENON - VOLLEDIG DICHT, POLYCARBONAAT

STROBE XENON - complètement fermé, polycarbonat
STROBE XENON - completely closed, polycarbonat

Amber / single flash / 12-80 V / H 120 mm / Ø 120 mm

Vaste plaatsing / montage fixe / fixed mounting

Magnetische plaatsing / montage magnétique / magnetic mounting

ref. SLA432AV
ref. SLA432AVM

**2 SYNCHRO BLITZ LAMPEN LED**

2 lampes flash synchro LED
2 synchro LED lights

Ø 230 mm / 12 - 24V

Opening voor paal- of bakenbevestiging
avec ouverture pour fixation sur poteaux ou balises
with opening for pole or beacon mounting

ref. SLABF230LED

Ø 340 mm / 12 - 24V

Met beugel / avec bride / with bracket ref. SLABF340LED

Kan ook op bakens geplaatst worden (zie p. 27)
Montage sur balises possible (voir p. 27)
Beacon mounting possible (see p. 27)



Ø 230 mm



Ø 340 mm

FLASHMATE, LED SIGNALISATIE

Flashmate, signalisation LED
Flashmate, LED signal lights

Blauw, 4 gele pijlen, oranje LED
Bleu, 4 flèches jaunes, LED orange
Blue, 4 yellow arrows, orange LED

ref. SLAFLASHMB

Rood, 4 witte pijlen, oranje LED
Rouge, 4 flèches blanches, LED orange
Red, 4 white arrows, orange LED

ref. SLAFLASHMR

Bevestiging magnetisch + zuignap
Fixation magnétique + ventouse
Fixation magnetic + suction cup



E 3. PINKLAMPEN - Lampes de chantier - Warning lights

**STANDAARD PINKLAMPEN / WERFLAMPEN (DAGSLAPER)**

Lampes de chantier standard (photocel)
Standard warning lamps (photocell)

Excl. 2 x 6V battery

Met beugel / avec bride / with bracket
Interne schakelaar / interrupteur interne / internal switch
UIT-pinken-continu / ETEINT-clignotant-continu / OFF-blink-continuous

Ø 180 mm, 2-sided

■ ref. SILA180LG
■ ref. SILA180LR
■ ref. SILA180LB

Ø 180 mm, 1-sided

met beugel / avec bride / with bracket ref. SILA180LGE
zonder beugel / sans bride / without bracket ref. SILA180LGE



E 4. XENONLAMPEN - Lampes xénon - Xenon blitzers

**XENON BLITZER MET BEUGEL**

Lampe xénon avec bride
Xenon blitzer with bracket

excl. 2 x 6V Batt.
1-sided

Int. schakelaar / interrupteur int. / int. switch

Ø 180 mm

■ ref. SILA180XNG

■ ref. SILA180XNB

Ø 200 mm

■ ref. SILA200XNG

■ ref. SILA200XNB

Ext. schakelaar / interrupteur ext. / ext. switch

Ø 180 mm

■ ref. SILA180XNGE

■ ref. SILA180XNBE

**MONOLIGHT PINKLAMP (DAGSLAPER)**

Lampe de chantier MONOLIGHT (photocel)
MONOLIGHT warning light (photocell)

Excl. 1 x 6V battery

Met beugel / avec bride / with bracket
Interne schakelaar / interrupteur interne / internal switch
UIT-pinken-continu / ETEINT-clignotant-continu / OFF-blink-continuous

Ø 180 mm, 2-sided

ref. SILAMONOG

ZIE OOK / VOIR AUSSI / SEE ALSO
6V battery

ref. SIBAW6V

**LED STAR FLASH**

Ø 200 mm
2-sided

■ ref. SILA20FLED

ext. schakelaar / interrupteur ext. / ext. switch
excl. 2 x 6V battery

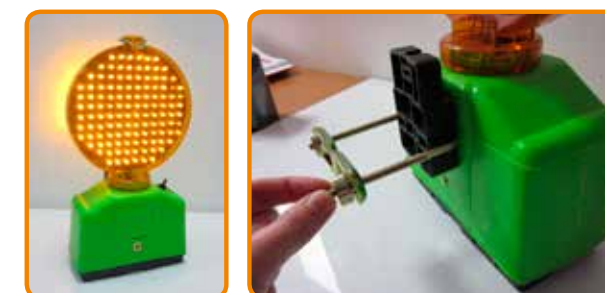
**SLEUTEL VOOR PINKLAMPEN MET INTERNE SCHAKELAAR**

Clef pour lampes de chantier avec interrupteur interne
Key for warning lights with internal switch

ref. SILASLPINK

**DRAAGBARE XENON FLASH**

Flash xénon portable
Portable xenon flash

excl. 2 x 6V battery, 360°

■ ref. SLAM735SR

■ ref. SLAM735SB

■ ref. SLAM735SA

■ ref. SLAM735SG

**SET 4 SYNCHRONISERENDE LAMPEN IN HERLAAD-/TRANSPORT BOX**

Set 4 lampes synchronisantes en bac de transport rechargeable
Set 4 synchronizing lamps in transport/recharger box

Set 470 x 220 x 470 mm – ± 1,800 kg / lamp
60 bl / minute, DAY 500 cd, NIGHT 250 cd

Conform / Compliant with EN12352

- **Eénzijdige lens ø 200 mm (geel/rood/blauw)**
 - **Supergemakkelijke en automatische synchronisatie met ongelimiteerd aantal lampen**
 - **Lampen ook afzonderlijk te gebruiken**
 - **Grote stabiliteit door draaibare voet**
 - **Transport box voorzien van 12/24V laders**
 - **Zeer krachtig, maar voorzien van lichtsensor dus nooit verblindend**
 - **2 functies : synchroniserend of sequentieel aflopend**
- Lentille uni-face ø 200 mm (jaune/rouge/bleu)
 - Synchronisation automatique hyper facile avec n'importe quelle quantité de lampes
 - Lampes aussi utilisables séparément
 - Grande stabilité par pieds tournants
 - Bac de transport avec chargeurs 12/24V
 - Lumière très forte mais par le sensor, jamais éblouissant
 - 2 fonctions: synchronisation ou en séquence
- *One-sided lens ø 200 mm (yellow/red/blue)*
 - *Very easy and automatic synchronization with unlimited number of lamps*
 - *Lamps can also be used separately*
 - *Good stability with rotating feet*
 - *Transport box with 12/24V charger*
 - *High light intensity but never blinding because of light sensor*
 - *2 functions: synchronized or sequential*



ref. SILASEQLEDRB
SILASEQLEDRG
SILASEQLEDRR

**Zie ook: adapter om lamp op kegel te plaatsen (onder ø 37 mm)**

Voir aussi: adaptateur pour placer lampe sur cône (ø dessous 37 mm)
See also : adaptor to place lamp on traffic cone (lower ø 37 mm)

ref. SILANISSAD

**E 5. SPECIALS - Spécialités - Specials****TELESCOPISCHE LAMP**

Lampe télescopique
Telescopic lamp

Auto-synchro - Ø 210 mm - 80 LED H.I.

Uittrekbaar tot 1 m
Verzwaarde voet van 5 kg
Interne schakelaar
Enkele of dubbele flash
Dag / nacht - UIT - dagslaper

Extensible jusqu'à 1 m
Base alourdi de 5 kg
Interrupteur interne
Flash simple ou double
Jour / nuit - ETEINT - photocel

Adjustable till 1 m
Heavy base of 5 kg
Internal switch
Single or double flash
Day / night - OFF - photocell

Excl. 4 x 6V Batt.

ref. SILATELES11

**BAKENLAMP**

Lampe pour balise
Beacon lamp

2-sided, Ø 200 mm
excl. 2 x 6 V battery

ref. SILABAKL

**CAMP LITE**

360°, 60 à 70 bl. / min, 5 cd, 110 x 280 x 120 mm
Flashing/continuous

Met beugel / avec bride / with bracket
Ext. schakelaar / interrupteur ext. / ext. switch
Wit licht / lumière blanche / white light 4 LED

excl. 1 x 6 V battery

ref. SILACAMP

**HELIPORTFLASH**

Geschikt voor / approprié pour / suited for
230 V, 60/75 W, E27 fitting

ref. SILAFLASH2



E 6. TOORTSLAMPEN - Lampes à mains - Torches

**LED SIGNALISATIETOORTS**

Bâton lumineux LED
LED torch

1. L 400 mm, Ø 30 mm, excl. 2C-batt. ref. SILIST02K
2. L 530 mm, Ø 45 mm, excl. 2D-batt. ref. SILIST02B

UIT / knipperen / continu

ETEINT / clignotant / continu
OFF / blink / continuous

MAG-LITE

2-cell D batt. (excl.)
L 245 mm, 0,675 kg, Ø 57 mm
3 m = 40,6 Lumen

ref. SITOORTPO2D

5-cell D batt. (excl.)
L 434 mm, 1,233 kg, Ø 57 mm
3 m = 161 Lumen

ref. SITOORTPO5D

OPZETSTUK

pièce adaptateur
adaptor

ref. SITOORTPOK

MAG+CHARGER

L 320 mm, 0,907 kg
240 Lumen, 47167 cd, **bereik** / range 434 m !

5-cell NIMH (6V) rechargeable battery pack incl.
+ charger 220 /12 V

Funcities / fonctions :

- **Vol vermogen** / full power
- **Spaarmodus** / eco mode
- **Knipperen** / clignoter / blink 5 x / sec.
- **SOS**
- **Continu** / continuous

ref. SITOORTPOM

RICHTBARE HANDLAMP

Lampe à main ajustable
Adjustable torch

incl. 3 kleurlenzen
Zichtbaar tot op 500 m

Incl. 3 lentilles colorées
Visible jusqu'à 500 m

incl. 3 coloured lenses.
Visible up to 500 m

Flash / OFF / continuous - 60 bl. / min - External switch

excl. 2 x 6V battery

ref. SITO00H

Version LED

ref. SITO00HLED

Ø 110 mm lenzen / lentilles / lenses

● ref. SITO00HLR / ● ref. SITO00HLG / ● ref. SITO00HLGR

**HEROPLAADBARE TOORTSLAMP**

Lampe à main rechargeable
Rechargeable torch

ref. SITOORTH

Incl. charger 4,8V / 4 Ah, Ni-Ca battery

**TOORTSLAMP**

Lampe à main
Torch

L 205 mm / Ø 115 mm / 0,2 kg
excl. 1 x 6V battery

ref. SITOORT



E 7. BATTERIJEN - Batteries

6V ECO BATTERIJEN HEAVY DUTY

6V Eco piles heavy duty
6V Eco batteries heavy duty

6V, 7 Ah, 0,6 kg
box = 24 pcs, 📦 = 1728 pcs

ref. SIBAW6V

**Batterijen 1,5V**

Batteries 1,5V
C-cell (LR14)
D-cell Batt. (LR20)

ref. SIBAWLR14

ref. SIBAWLR2

**NIKKEL CADMIUM HERLAADBARE BATTERIJ**

Nickel Cadmium batterij rechargeable
Nickel Cadmium rechargeable battery

5v - 4,5Ah

ref. SIBAW5VR



E 8. VERKEERSLICHTEN - Feux de signalisation - Traffic lights



SET 2 MOBIELE VERKEERSLICHTEN HALOGEEN

Set 2 feux de signalisation halogène mobiles
Set 2 mobile halogen traffic lights

Voor 2-richtingsverkeer
Gelijkstroom: 10-14V
Eenvoudige configuratie met afstandsbediening

Pour trafic en 2 directions
Voltage direct: 10-14V
Configuration facile par télécommande

For 2-way traffic
Direct voltage
Easy configuration with remote control



Lens Ø 210 mm

ref. SIVERKLISET

SET 2 MOBIELE VERKEERSLICHTEN LED

Set 2 feux de signalisation LED mobiles
Set 2 mobile LED traffic lights

1200 x 800 mm

ref. SIVERKLISETL

SET 4 MOBIELE VERKEERSLICHTEN VOOR KRUISPUNT

Set 4 feux de signalisation mobiles pour carrefour
Set 4 mobile traffic lights for crossroad

ref. SIVERKLISET4



VERKEERSLICHT 1-, 2- OF 3-DELIG

Feu de signalisation 1, 2 ou 3 pièces
Traffic light 1, 2 or 3 pieces

Ø	Delen Pièces Pieces	Halogeen/ LED	Ref.
200	1	Halogeen	SIVERKLI21
	2	Halogeen	SIVERKLI22
	3	Halogeen	SIVERKLI23
	1	LED	SIVERKLI21LED
	2	LED	SIVERKLI22LED
	3	LED	SIVERKLI23LED
300	1	Halogeen	SIVERKLI31
	2	LED	SIVERKLI32LED

Lenskleur bevestigen bij bestelling AUB

Veillez préciser couleur de la lentille lors de la commande s.v.p.
Please specify lens colour at order

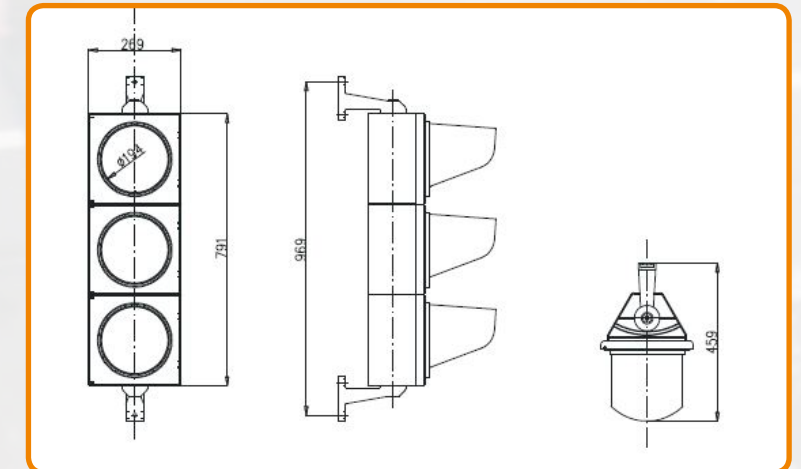
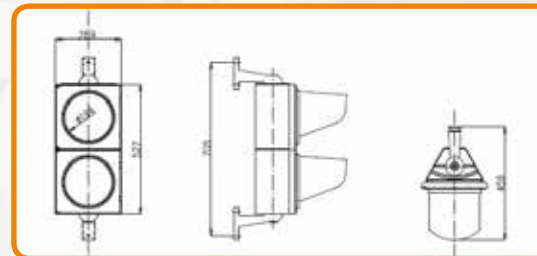
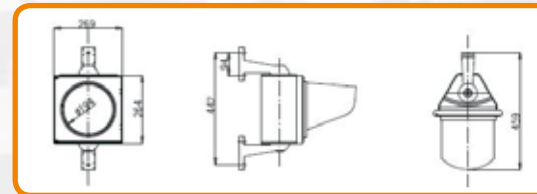

DON'T FORGET!

Semi-tractie batterij 12V/230 AH, 20 u

Batterie semi-traction 12V/230 AH, 20 h
Semi-traction battery 12V/230 AH, 20 h

ref. SIVERKLISETB

Automatische lader, 12V, 30A

Chargeur automatique, 12V, 30A
Automatic charger, 12V, 30A

ref. SIVERKLISETC



BI-FLASH LED + PAALBEVESTIGING

Bi-flash LED + fixation poteau
pole fixation

66 x 30 x 230 mm, 220 / 240 V
Poly carbonate lens / lentille / lens Ø 130 mm

horizonta(a)
vertica(a)

ref. SIVERKLITWH
ref. SIVERKLITWV